

10096-8-NE

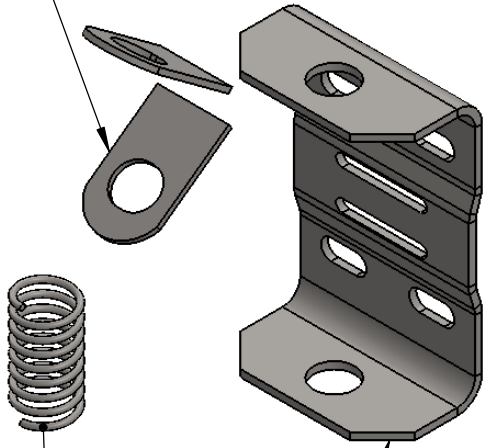

10096-8-1E

10096-8-PE

10096-8-3

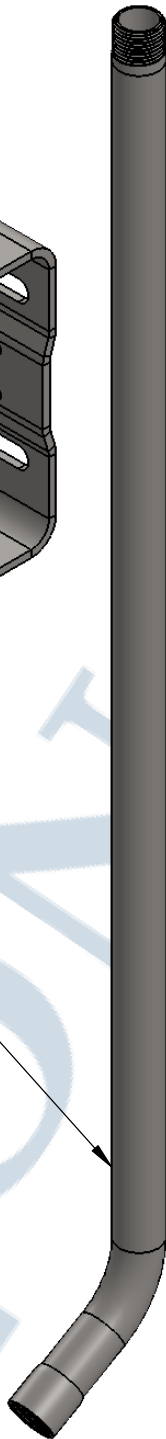

650

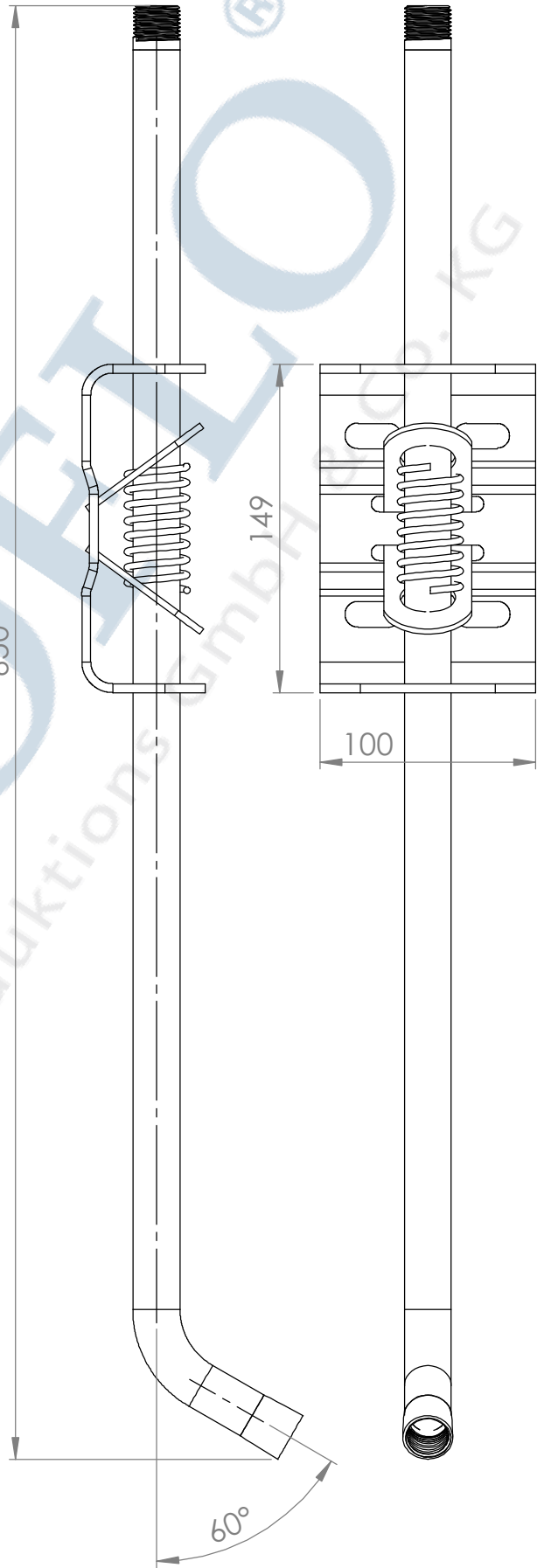

DATE DRAWN 30.09.2014

MATERIAL:

AISI 304

PART NAME:

10096-8-VE

1st revision

Total Net weight: 1527.38 gr

2nd revision

NOTES:

3rd revision

Last revision

SCALE: 1:5

PAGE 1 / 1

A4